

P_PO-1.5NR-4X6

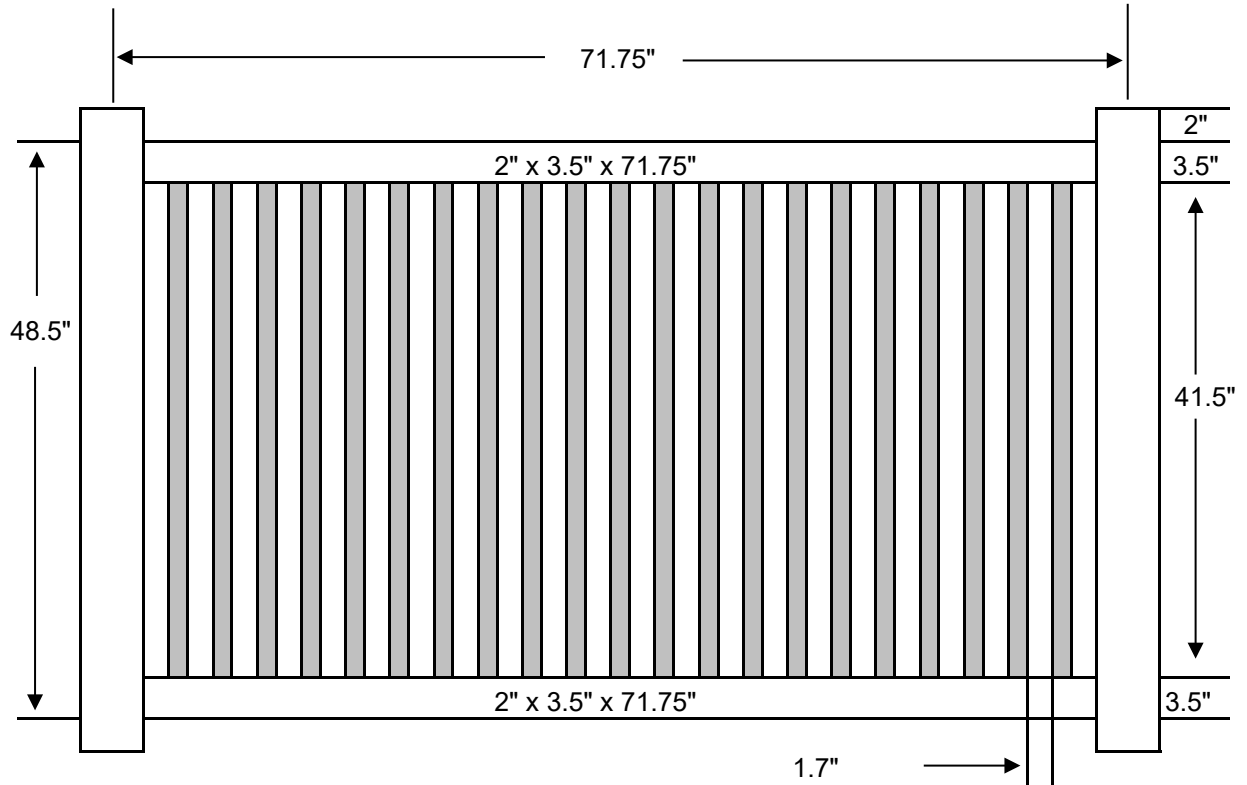

1	Material List		Pulled From		
	Qty	Item	Dimension	White	Tan
2	Rails	2" x 3.5" x 71.75"	71.75"	71.75"	71.75"
1	Aluminum	1.5" x 3.25" x 71.5"	71.5"	71.5"	71.5"
21	Pickets	0.875" x 1.5" x 47"	47"	193.25"	193.25"

P_PO-1.5NR-4X6

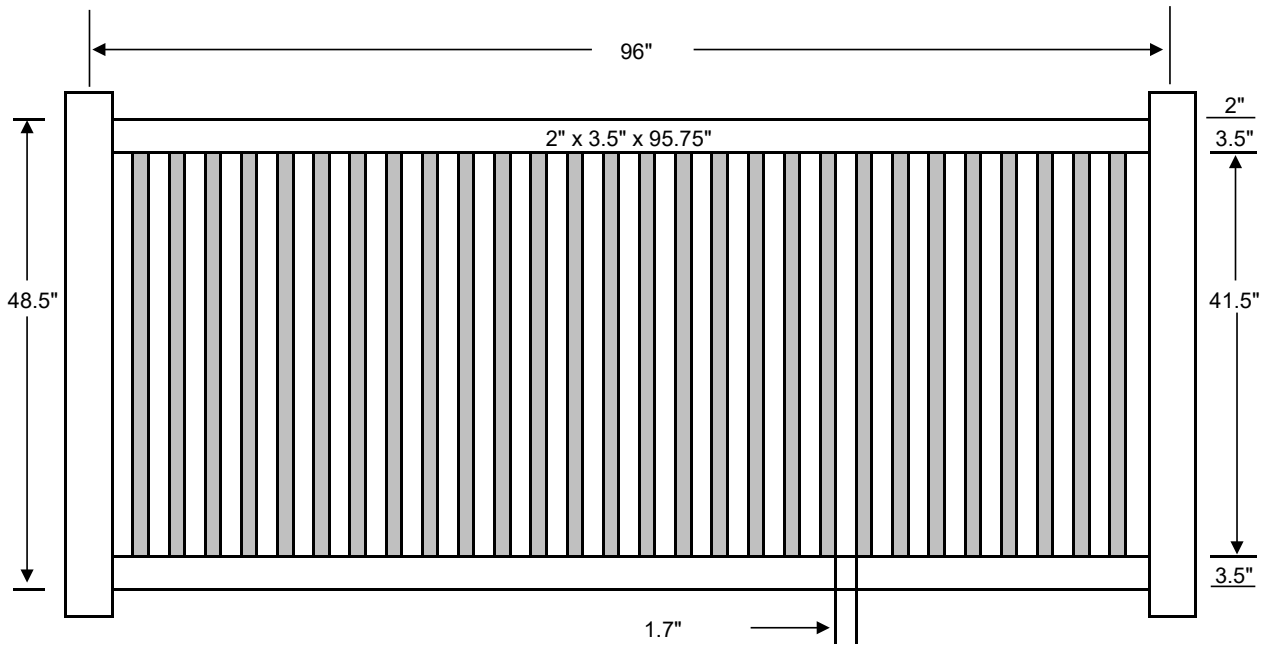

1	Material List		Pulled From		
	Qty	Item	Dimension	White	Tan
2	Rails	2" x 3.5" x 95.75"	95.75"	95.75"	95.75"
1	Aluminum	1.5" x 3.25" x 95.5"	95.5"	95.5"	95.5"
28	Pickets	0.875" x 1.5" x 47"	47"	193.25"	193.25"

P_PO-1.5NR-4X8

G_PO-1.5NR-4X36

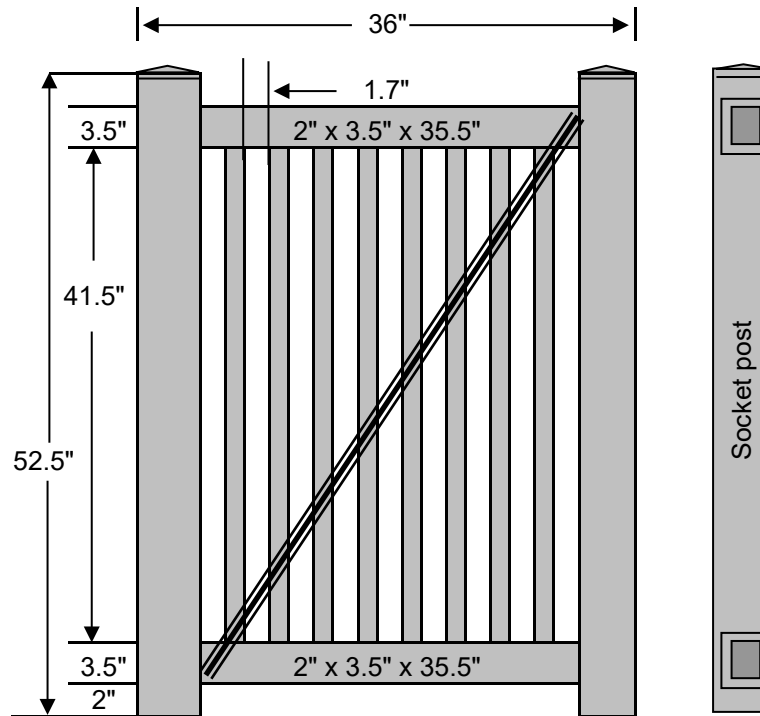

1

Material List			Pulled From		
Qty	Item	Dimension	White	Tan	Khaki
2	Socket Posts	4" x 4" x 52.5"	108"	108"	108"
2	Post Caps	4" x 4"	4"	4"	4"
2	Rails	2" x 3.5" x 35.5"	71.75"	71.75"	71.75"
1	Aluminum	1.5" x 3.25" x 35"	71.5"	71.5"	71.5"
1	Cross Brace	Cross Brace	90"	90"	90"
8	Pickets	0.875" x 1.5" x 47"	47"	193.25"	193.25"
1	Cross Brace Screws & Caps				
1	Vinyl Fence Glue		1.5 Oz	1.5 Oz	1.5 Oz

G_PO-1.5NR-4X36

G_PO-1.5NR-4X48

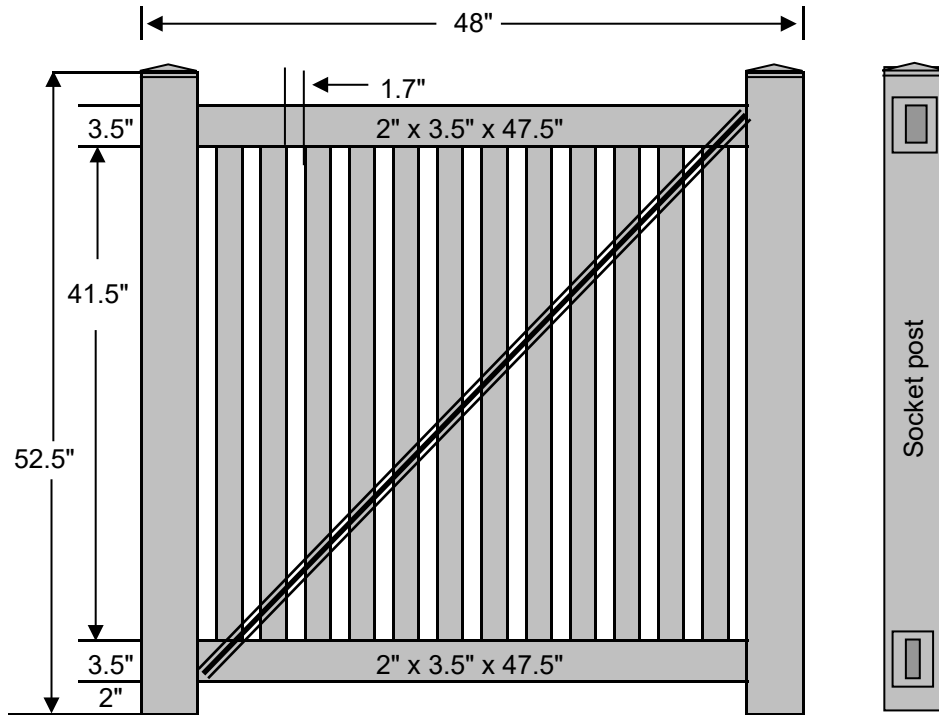

1

Material List			Pulled From		
Qty	Item	Dimension	White	Tan	Khaki
2	Socket Posts	4" x 4" x 52.5"	108"	108"	108"
2	Post Caps	4" x 4"	4"	4"	4"
2	Rails	2" x 3.5" x 47.5"	95.75"	95.75"	95.75"
1	Aluminum	1.5" x 3.25" x 47"	95.5"	95.5"	95.5"
1	Cross Brace	Cross Brace	90"	90"	90"
12	Pickets	0.875" x 1.5" x 47"	47"	193.25"	193.25"
1	Cross Brace Screws & Caps				
1	Vinyl Fence Glue		1.5 Oz	1.5 Oz	1.5 Oz

G_PO-1.5NR-4X48

G_PO-1.5NR-4X60

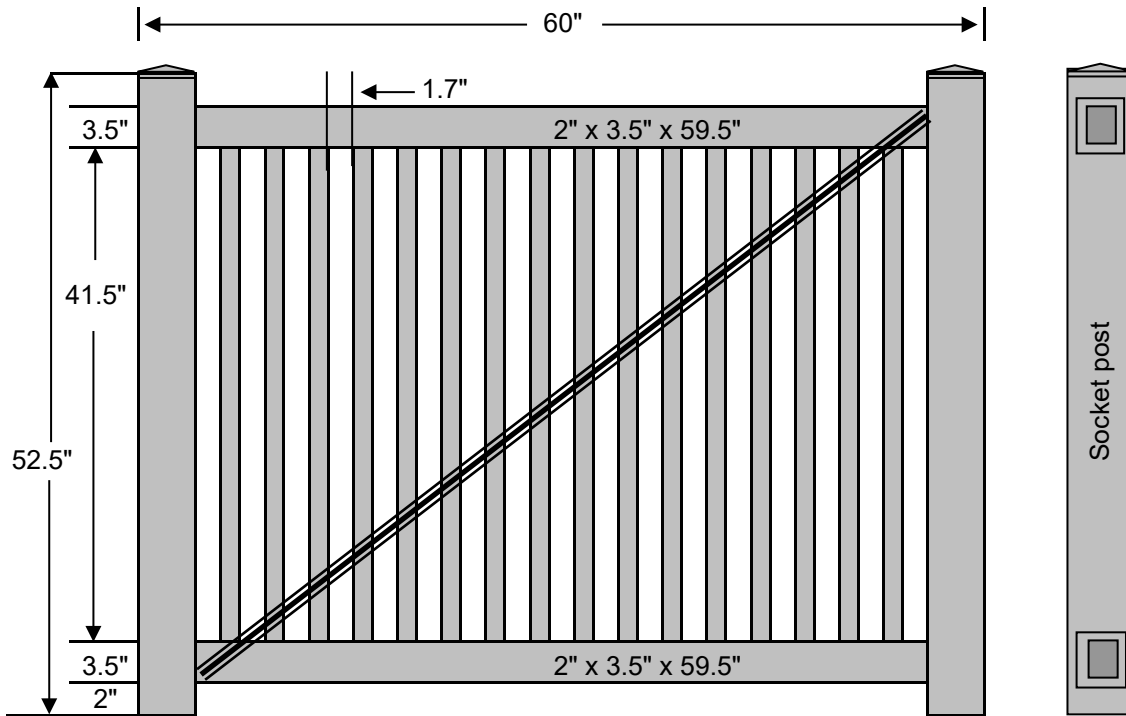

1 Material List			Pulled From		
Qty	Item	Dimension	White	Tan	Khaki
2	Socket Posts	4" x 4" x 52.5"	108"	108"	108"
2	Post Caps	4" x 4"	4"	4"	4"
2	Rails	2" x 3.5" x 59.5"	71.75"	71.75"	71.75"
1	Aluminum	1.5" x 3.25" x 59"	71.5"	71.5"	71.5"
1	Cross Brace	Cross Brace	90"	90"	90"
16	Pickets	0.875" x 1.5" x 47"	47"	193.25"	193.25"
1	Cross Brace Screws & Caps				
1	Vinyl Fence Glue		1.5 Oz	1.5 Oz	1.5 Oz

G_PO-1.5NR-4X60

G_PO-1.5NR-4X72

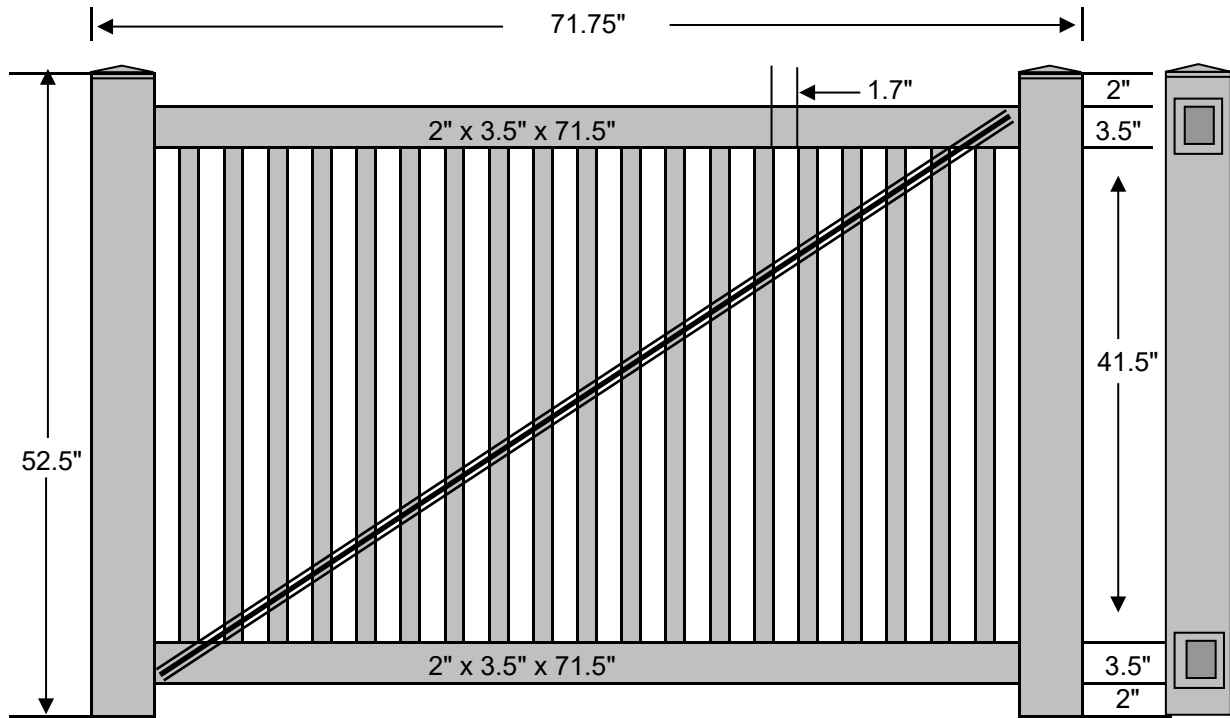

1		Material List	Pulled From		
Qty	Item	Dimension	White	Tan	Khaki
2	Socket Posts	4" x 4" x 52.5"	108"	108"	108"
2	Post Caps	4" x 4"	4"	4"	4"
2	Rails	2" x 3.5" x 71.5"	71.75"	71.75"	71.75"
1	Aluminum	1.5" x 3.25" x 71"	71.5"	71.5"	71.5"
1	Cross Brace	Cross Brace	90"	90"	90"
19	Pickets	0.875" x 1.5" x 47"	47"	193.25"	193.25"
1	Cross Brace Screws & Caps				
1	Vinyl Fence Glue		1.5 Oz	1.5 Oz	1.5 Oz

G_PO-1.5NR-4X72

P_PO-1.5NR-5X6

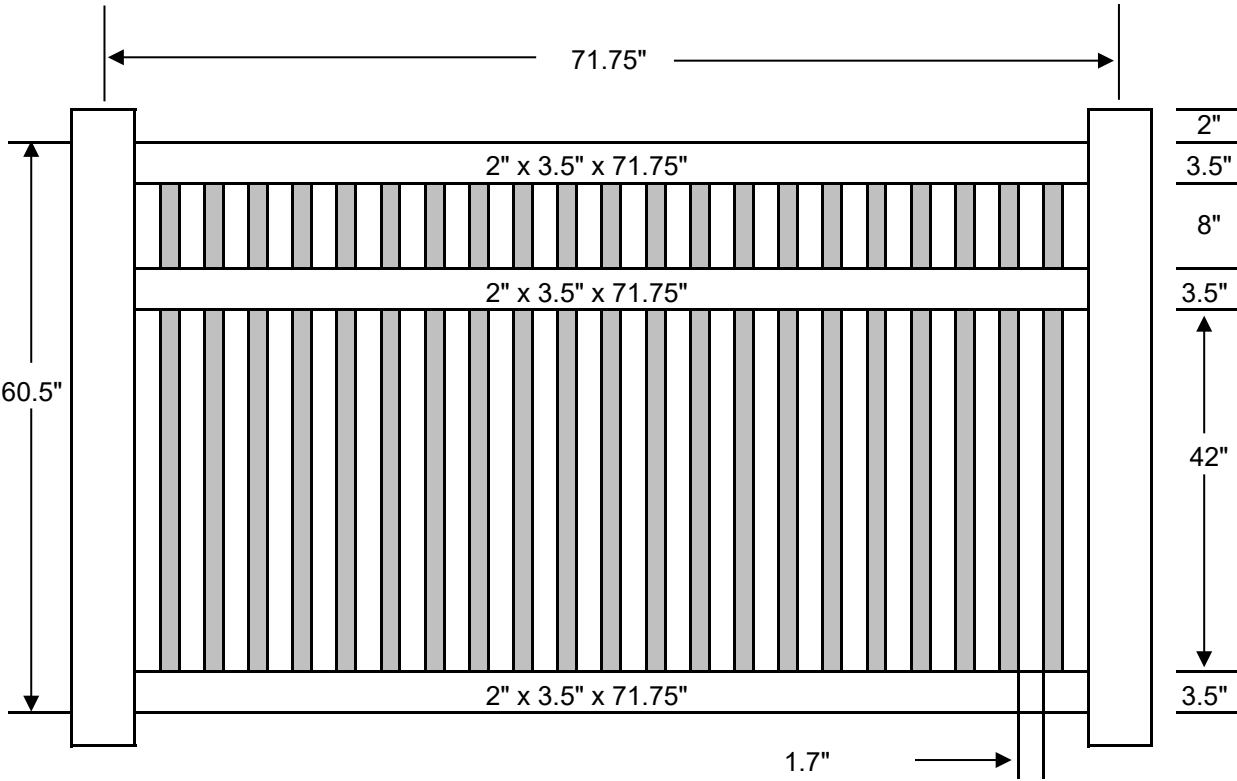

1	Material List		Pulled From		
	Qty	Item	Dimension	White	Tan
2	Rails	2" x 3.5" x 71.75"	71.75"	71.75"	71.75"
1	Mid Rail	2" x 3.5" x 71.75"	71.75"	71.75"	71.75"
1	Aluminum	1.5" x 3.25" x 71.5"	71.5"	71.5"	71.5"
21	Pickets	0.875" x 1.5" x 59"	59"	193.25"	193.25"

P_PO-1.5NR-5X6

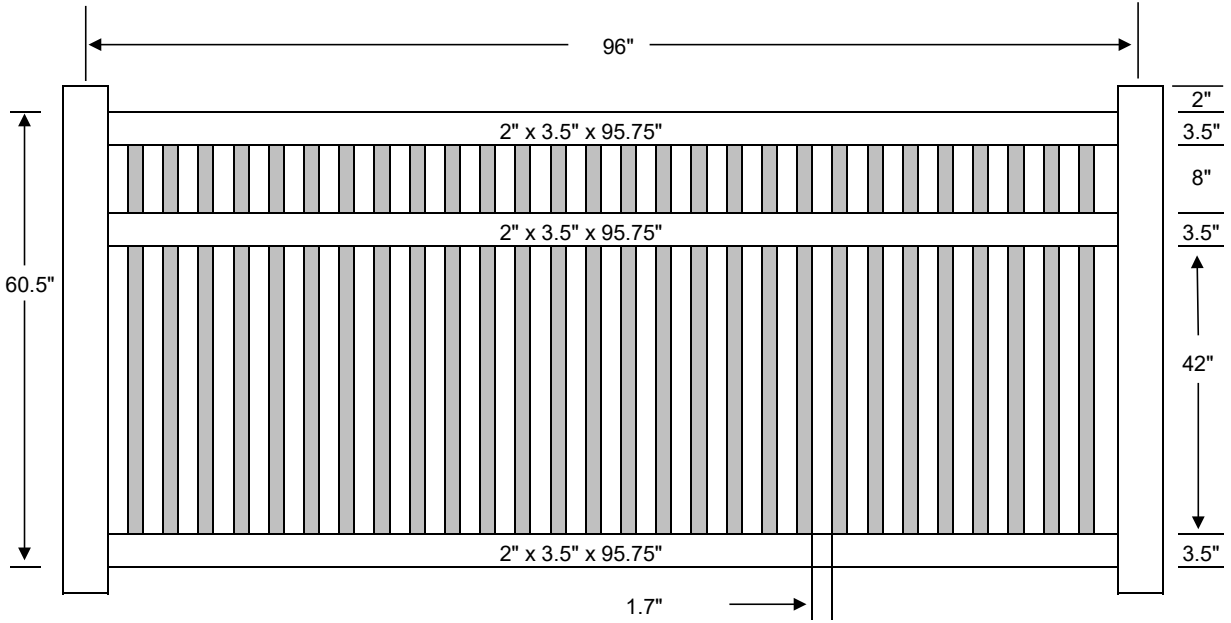

1	Material List		Pulled From		
	Qty	Item	Dimension	White	Tan
2	Top & Bottom Rails	2" x 3.5" x 95.75"	95.75"	95.75"	95.75"
1	Mid Rail	2" x 3.5" x 95.75"	95.75"	95.75"	95.75"
1	Aluminum	1.5" x 3.25" x 95.5"	95.5"	95.5"	95.5"
28	Pickets	0.875" x 1.5" x 59"	59"	193.25"	193.25"
P_PO-1.5NR-5X8					

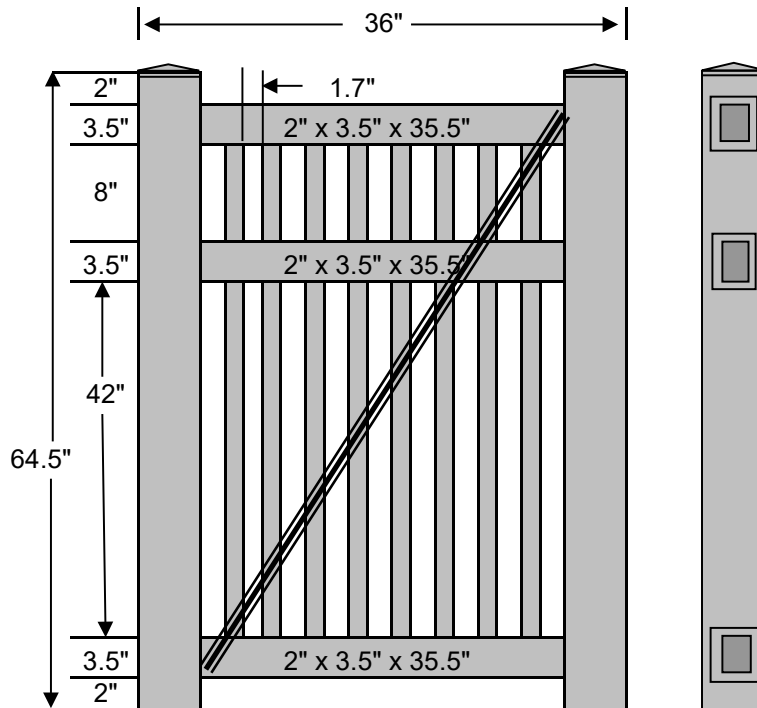

1	Material List		Pulled From		
	Qty	Item	Dimension	White	Tan
2	Socket Posts	4" x 4" x 64.5"	71.75"	84"	84"
2	Post Caps	4" x 4"	4"	4"	4"
2	Top & Bottom Rails	2" x 3.5" x 35.5"	71.75"	71.75"	71.75"
1	Mid Rail	2" x 3.5" x 35.5"	71.75"	71.75"	71.75"
1	Aluminum	1.5" x 3.25" x 35"	71.5"	71.5"	71.5"
1	Cross Brace	Cross Brace	90"	90"	90"
8	Pickets	0.875" x 1.5" x 59"	59"	193.25"	193.25"
1	Cross Brace Screws & Caps				
1	Vinyl Fence Glue		1.5 Oz	1.5 Oz	1.5 Oz

G_PO-1.5NR-5X36

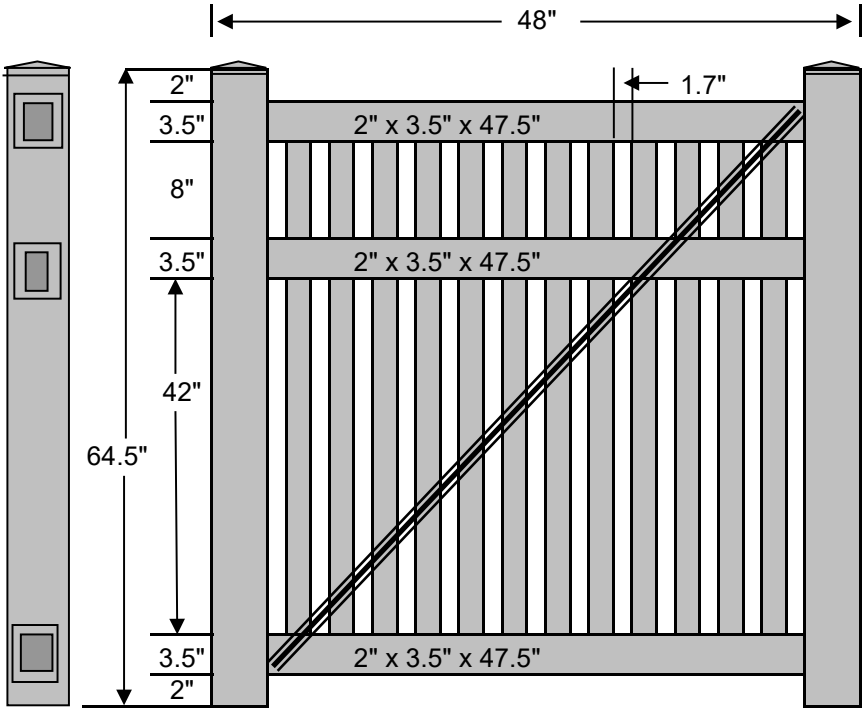

1			Material List		Pulled From		
Qty	Item	Dimension	White	Tan	Khaki		
2	Socket Posts	4" x 4" x 64.5"	71.75"	84"	84"		
2	Post Caps	4" x 4"	4"	4"	4"		
2	Top & Bott Rails	2" x 3.5" x 47.5"	95.75"	95.75"	95.75"		
1	Mid Rail	2" x 3.5" x 47.5"	95.75"	95.75"	95.75"		
1	Aluminum	1.5" x 3.25" x 47"	95.5"	95.5"	95.5"		
1	Cross Brace	Cross Brace	90"	90"	90"		
12	Pickets	0.875" x 1.5" x 59"	59"	193.25"	193.25"		
1	Cross Brace Screws & Caps						
1	Vinyl Fence Glue		1.5 Oz	1.5 Oz	1.5 Oz		
			G_PO-1.5NR-5X48				

G_PO-1.5NR-5X60

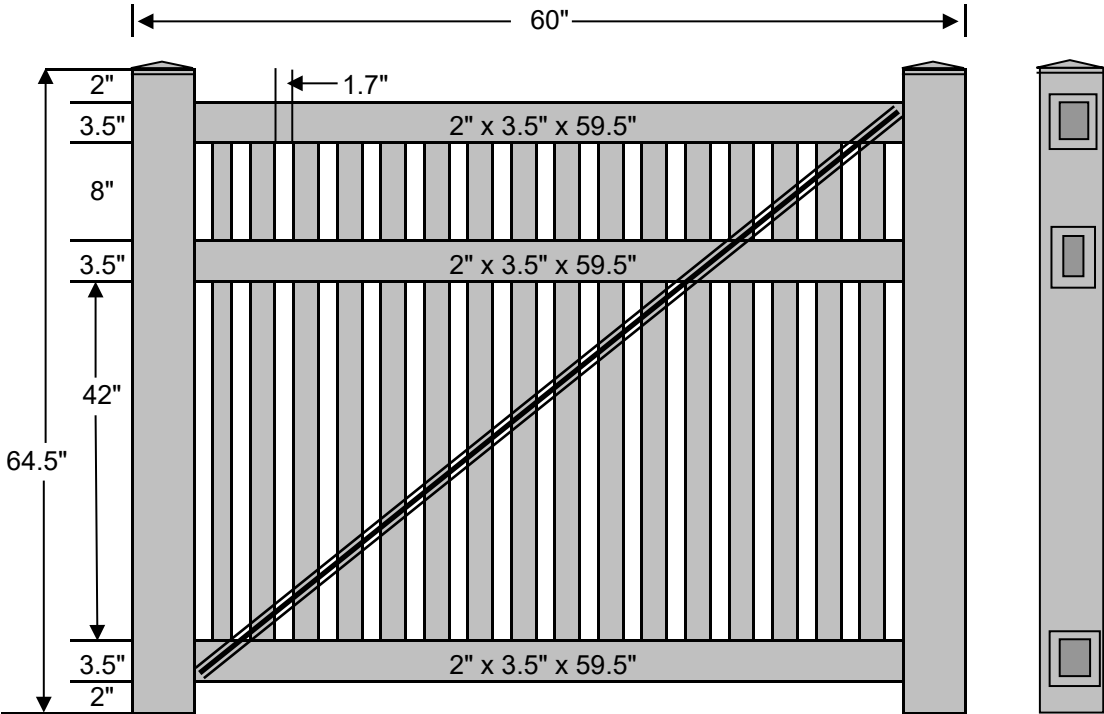

1		Material List		Pulled From		
Qty	Item	Dimension	White	Tan	Khaki	
2	Socket Posts	4" x 4" x 64.5"	71.75"	84"	84"	
2	Post Caps	4" x 4"	4"	4"	4"	
2	Top & Bottom Rail	2" x 3.5" x 59.5"	71.75"	71.75"	71.75"	
1	Mid Rail	2" x 3.5" x 59.5"	71.75"	71.75"	71.75"	
1	Aluminum	1.5" x 3.25" x 59"	71.5"	71.5"	71.5"	
1	Cross Brace	Cross Brace	90"	90"	90"	
16	Pickets	0.875" x 1.5" x 59"	59"	193.25"	193.25"	
1	Cross Brace Screws & Caps					
1	Vinyl Fence Glue		1.5 Oz	1.5 Oz	1.5 Oz	
			G_PO-1.5NR-5X60			

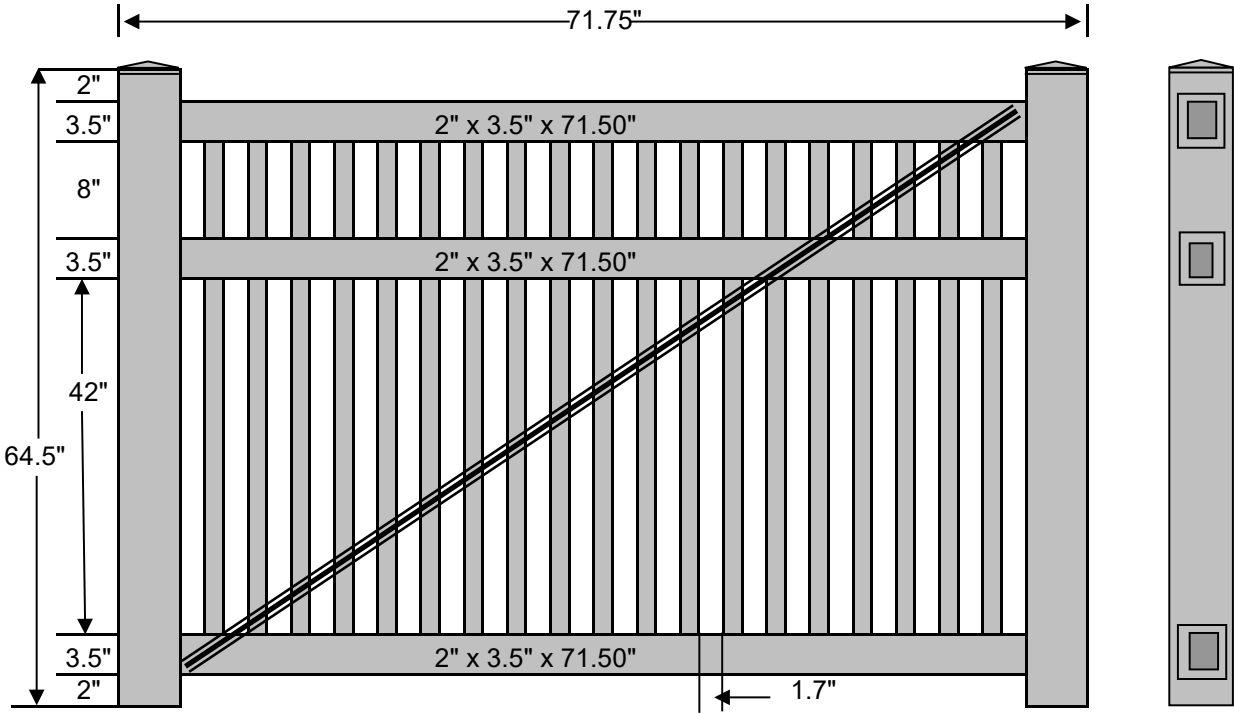

1	Material List		Pulled From		
	Qty	Item	Dimension	White	Tan
2	Socket Posts	4" x 4" x 64.5"	71.75"	84"	84"
2	Post Caps	4" x 4"	4"	4"	4"
2	Top & Bottom Rails	2" x 3.5" x 71.5"	71.75"	71.75"	71.75"
1	Mid Rail	2" x 3.5" x 71.5"	71.75"	71.75"	71.75"
1	Aluminum	1.5" x 3.25" x 71"	71.5"	71.5"	71.5"
1	Cross Brace	Cross Brace	90"	90"	90"
19	Pickets	0.875" x 1.5" x 59"	59"	193.25"	193.25"
1	Cross Brace Screws & Caps				
1	Vinyl Fence Glue		1.5 Oz	1.5 Oz	1.5 Oz
			G_PO-1.5NR-5X72		

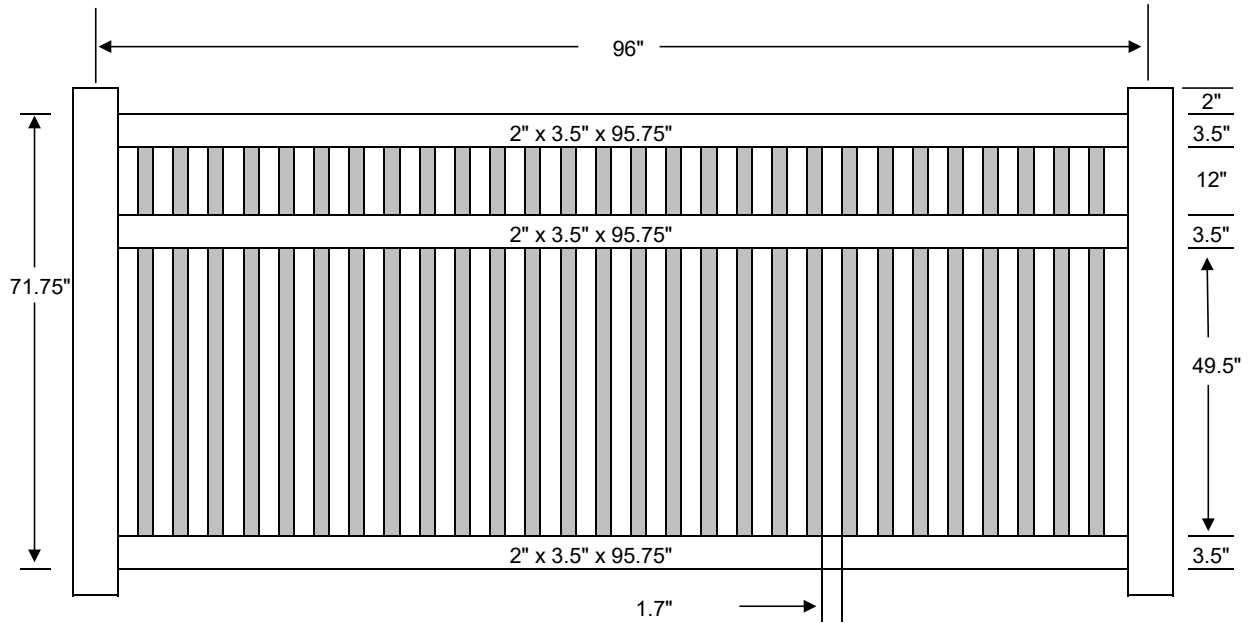

1	Material List		Pulled From		
	Qty	Item	Dimension	White	Tan
2	Top & Bottom Rails	2" x 3.5" x 95.75"	95.75"	95.75"	95.75"
1	Mid Rail	2" x 3.5" x 95.75"	95.75"	95.75"	95.75"
1	Aluminum	1.5" x 3.25" x 95.5"	95.5"	95.5"	95.5"
28	Pickets	0.875" x 1.5" x 70.5"	70.5"	193.25"	193.25"
			P_PO-1.5NR-6X8		

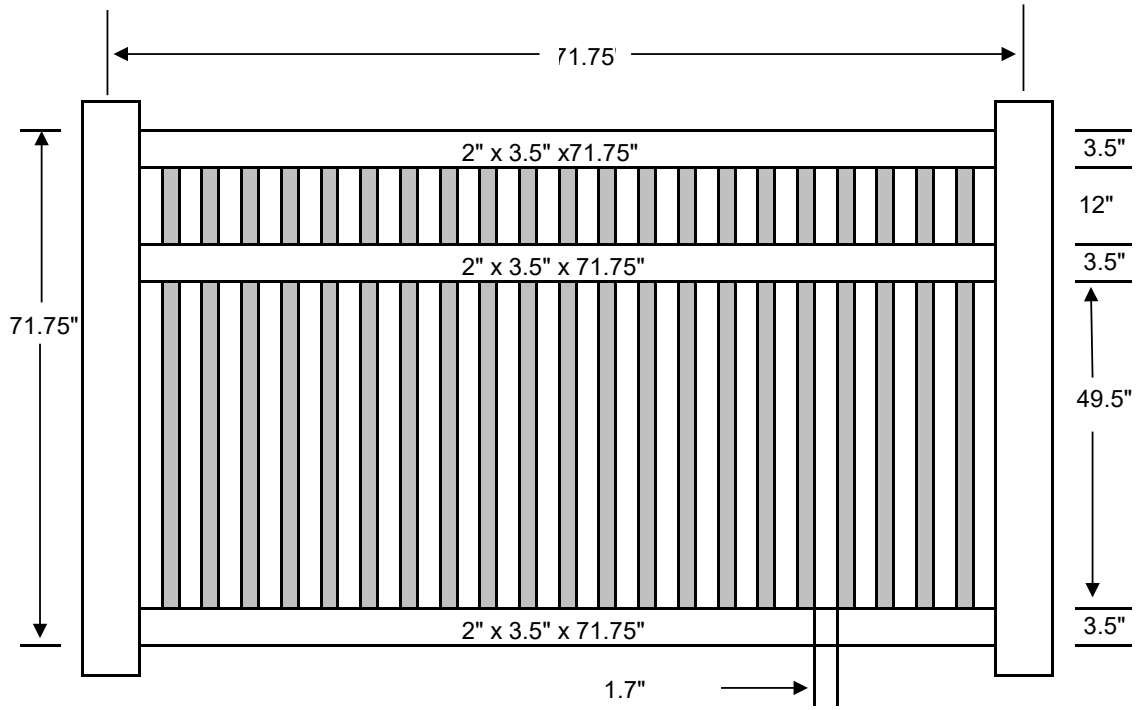

1 Material List			Pulled From		
Qty	Item	Dimension	White	Tan	Khaki
2	Top & Bottom Rails	2" x 3.5" x 71.75"	71.75"	71.75"	71.75"
1	Mid Rail	2" x 3.5" x 71.75"	71.75"	71.75"	71.75"
1	Aluminum	1.5" x 3.25" x 71.5"	71.5"	71.5"	71.5"
21	Pickets	0.875" x 1.5" x 70.5"	70.5"	193.25"	193.25"
			P_PO-1.5NR-6X6		